

# Design of Microstrip Antennas Arrays with Circular Patch at Frequency of 2.5 GHz

Otávio Paulino Lavor and Humberto C. C. Fernandes

**Abstract**— This paper analyses the influence of microstrip antenna arrays designed for a frequency of 2.5 GHz, aiming at applications in wireless communications. From a standard antenna with circular patch, elements are introduced to obtain linear and circular array, since arrays are interesting, whenever it want high gains. While the linear arrays are simple and practical, circular arrays can provide better symmetry. In case of the circular array, this also is considered with truncated ground plane, which shows applicable UWB communications. The prototypes are built and measured data are compared with the simulated data showing a good agreement.

**Index Terms**— Microstrip antenna, linear array, circular array, circular patch, gain, truncated ground plane.

## I. INTRODUCTION

Among the various types of antennas, one of the most used types due to its characteristics for application in modern communication systems are microstrip antenna [1]. Among the advantages of microstrip antennas, it can highlight: ease of shaping the flat and non-flat surfaces, simple construction, low cost, versatility in terms of the resonance frequency, polarization, impedance and radiation pattern. These kinds of antennas have some disadvantages, such as low efficiency, low power, low directivity and small bandwidth (of a few percent) [2].

These antennas play nowadays an important role in telecommunications, being available in a wide variety of settings [3].

Wireless communications turned out to be the most promising area for the application of antennas due to the quality of research being done, and to ensure the service.

The arrays are widely used, since in many applications, antennas with high gains are necessary. The main arrays are linear, planar and circular, and the linear array is the simple and practical [2]. Planar arrays are more versatile and may provide more symmetrical in relation to the diagrams linear array. Applications include tracking radar, search radar, remote sensing, communications and many other [2]. The circular array has applications in radar, sonar, spread underground and many others. These arrays have been

proposed for wireless communications and in particular to smart antennas [4].

In [5], is studied the influence of a semicircular array and in [6], a circular array is designed to operate at 15 GHz, where it was used rectangular elements.

An antenna with circular patch has been used in UWB (Ultra Wide Band) system, where the truncated ground plane was used [7]. This truncated ground plane also was used under new structures of impedances wedding [8]. Antenna UWB with circular patch also was designed with circular opening in ground plane [9].

Continuing a series of studies, this paper presents the results of the influence of a linear array with two elements and a circular array with four elements, where these elements are all circular. The purpose is to compare with a standard antenna designed for 2.5 GHz, 4G technology. In case of the circular array, this also is considered with truncated ground plane. Prototypes are built and measured and simulated data are compared.

## II. DESIGN OF THE STANDARD ANTENNA, LINEAR AND CIRCULAR ARRAY

The material used for the substrate is glass fiber (FR4) with relative permittivity ( $\epsilon_r$ ) of 4.4 and a thickness of 1.56mm. For design of standard antenna was used a circular patch structure with ray  $a = 16.8$  mm fed by a microstrip line of length  $b = 14.3$  mm and width  $w = 2.32$ mm. This radius value is obtained by the method of Transverse Transmission Line. The material for ground plane, patch and feed line is copper. The figure 1 shows the geometry of the patch of the standard antenna.

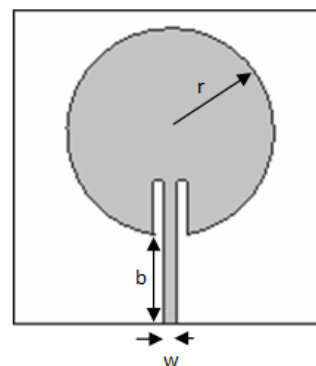

Fig. 1. Geometry of the standard patch.

For the linear array, are considered two elements, where the spacing between the elements is considered the same length of the fed line. Below, in figure 2, can be seen the geometry of a

Otávio Paulino Lavor is with the Campus Pau dos Ferros, Federal Rural University of Semiárid, Pau dos Ferros, Brasil (e-mail: otavioplavor@gmail.com).

Humberto César Chaves Fernandes is with the Electrical Engineering Department, Federal University of Rio Grande do Norte, Natal, Brasil (e-mail: humbecf@ct.ufrn.br).

linear array, where the dimensions are described above.

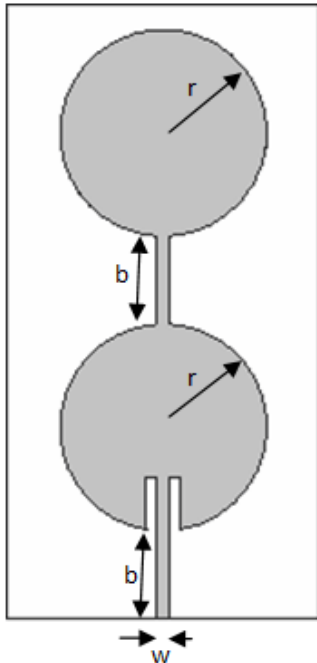

Fig. 2. Geometry of patch of an array with two elements.

For the circular array, four elements are considered. Figure 3 shows the geometry of this array, where the dimensions are the values described above. In this array, the distance between two opposite elements is  $c = 26.28$  mm.

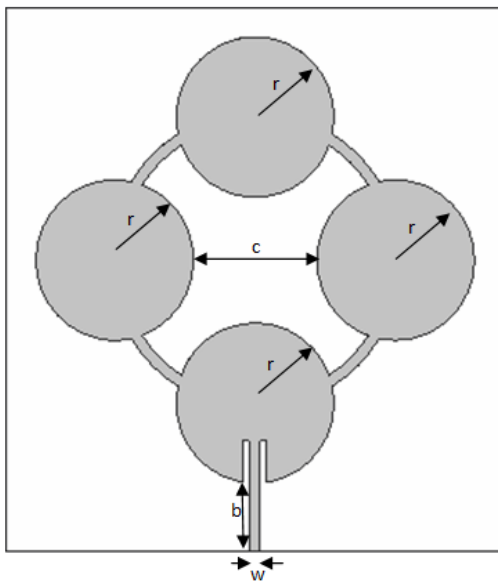

Fig. 3. Geometry of circular array with four elements.

This circular array also was considered with truncated ground plane, where the value of the fed line is reduced for 7.3 mm. Figure 4 shows a geometry truncated ground plane, where  $d=106$  mm,  $e=6.8$  mm,  $f=2$  mm and  $g=2.4$ mm.

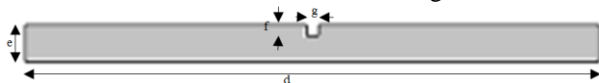

Fig. 4. Geometry of truncated ground plane.

### III. RESULTS

Simulations are done to compare the return loss of the standard antenna with proposed arrays. The comparisons are made with the standard antenna, linear array with two elements and the circular array with four elements.

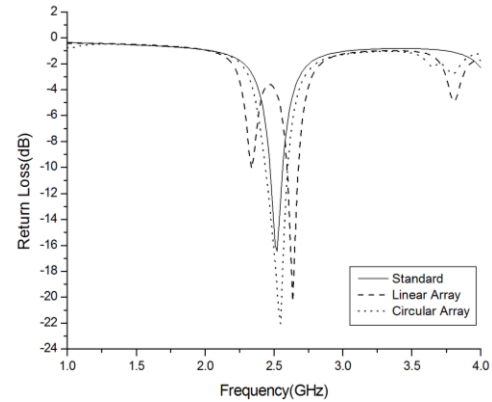

Fig. 5. Return loss versus frequency.

Here one sees a shift in frequency when the arrays are considered, in particular linear array. The circular array is one where the curve most closely matches the standard curve. The table 1 below shows the return loss for each resonance frequency.

Table 1. Return loss and resonance frequency.

Type of antenna	Frequency (GHz)	Return loss (dB)
Standard antenna	2.51	-16.69
Linear array	2.33	-10.34
	2.64	-20.34
Circular array	2.54	-22.04

The gain of the standard antenna and arrays was analyzed. Figure 6 shows the total gain as a function of angle.

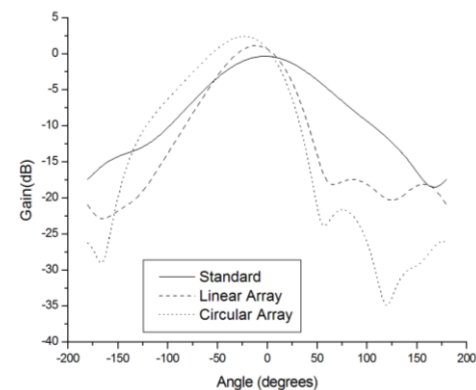

Fig. 6. Total gain of the standard antenna and arrays.

While the standard antenna has a gain of -0.35dB, the linear array with two elements has 1.11 dB and circular array has 2.4 dB. The dimensions were increased to achieve the array, but the gain it increased significantly. Therefore, arrays are interesting when you want a better gain to the antenna.

Prototypes were constructed in order to check the

simulations. The prototypes were built to the standard antenna, linear array with two elements and circular array. Pictures are seen below.



Fig. 7. Picture of the linear array.



Fig. 8. Picture of the circular array.

Once constructed, the prototypes of the arrays were analyzed so that the measured results are compared with the simulated. Comparisons are seen in the graphs of the figure 9 and 10.

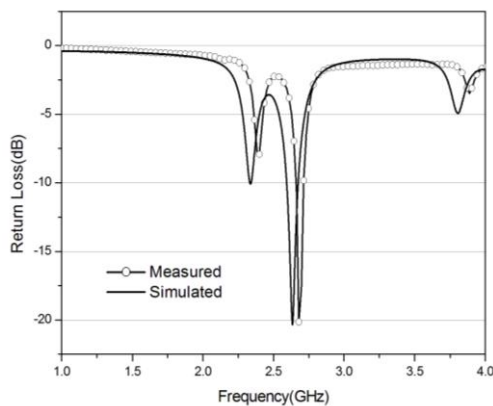

Fig. 9. Return loss of the linear array.

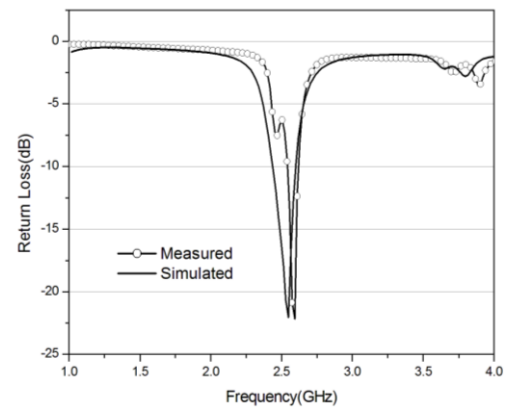

Fig. 10. Return loss of the circular array.

In all comparisons there was a shift in the frequency measured, but such displacement is very small and the measured return loss is less than or equal to the simulated, which leads to consider such as very satisfactory results.

In the figures 11 and 12, the measured input impedance can be seen in the Smith chart for these antennas.

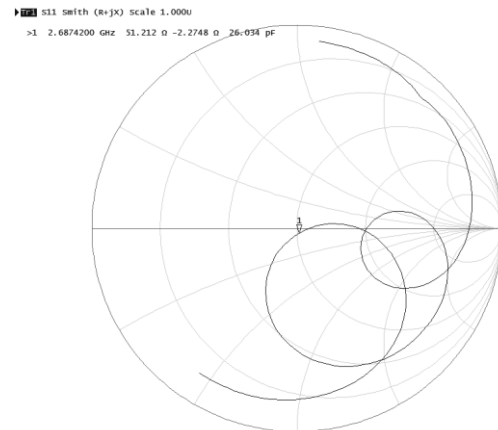

Fig. 11. Measured input impedance of the linear array.

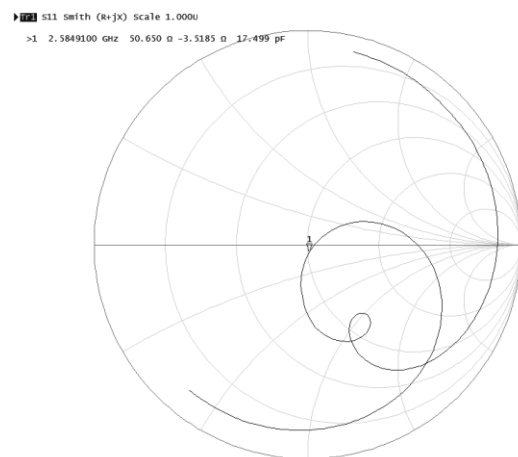

Fig. 12. Measured input impedance of the circular array.

The input impedance of the linear array with two elements is  $51.212 - 2.2748j$  ohms and of the circular array is  $50.65 - 3.5185j$  ohms. Based on an impedance of 50 ohms, the above values are very close.

The circular array with truncated ground plane also was built and your photograph is seen in figure 13.



Fig. 13. Picture of the circular array with truncated ground plane

Simulated and Measured data are presented in figure 14, where it can be seen that the prototype has bandwidth of the 2.1 to 8.5 GHz.

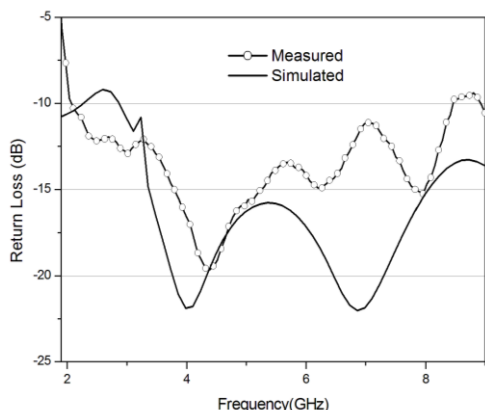

Fig. 14. Return loss of the circular array with truncated ground plane

#### IV. CONCLUSIONS

In this work, it was examined the influence of a linear and circular arrays for applications in wireless communications. The arrays were compared with a standard antenna of circular patch. The prototypes were built and measured data are in accordance with the simulated. The circular array with truncated ground plane was proposed and its prototype has presented bandwidth of 2.1 to 8.4 GHz. The small differences between measured and simulated data may be due to inaccuracies of the measures in the manufacturing process.

#### REFERENCES

[1] W. Y Qiang and F. Tao, "The Study on a Patch Antenna with PBG Structure", Third International Symposium on Intelligent Information Technology Application, Vol.3, 565-567, November 2009. doi: 10.1109/IITA.2009.424

[2] C. A. Balanis, *Antenna Theory – Analysis and Design*, Harper & Row, Publishers, 1982.

[3] D. C. Lacerda, "Design and construction of microstrip antenna for cellular mobile system", University of Brasilia, 2008.

[4] P. Ioannides and C. A. Balanis, "Uniform circular arrays for smart antennas", *Antennas and Propagation Magazine, IEEE*, Vol.47, No.4, 192-206, August 2005. doi: 10.1109/MAP.2005.1589932

[5] R. Sanudin and T. Arslan, "Semi-circular antenna array for azimuth DOA estimation", *Antennas and Propagation Conference (LAPC)*, 1-4, November 2012. doi: 10.1109/LAPC.2012.6402959

[6] S. Lizhong M. Ning, L. Chongshen and W. Qun, "Simulation and Analysis of a Microstrip Circular Array Antenna at 15GHz", 4th International Conference on Wireless Communications, Networking and Mobile Computing (WiCOM), 1-4, October 2008. doi: 10.1109/WiCom.2008.540

[7] M. P. Sousa Neto, H. C. C. Fernandes and C. G. Moura. "Design of a Ultrawideband Monopole Antenna Using Split Ring Resonator for Notching Frequencies," *Microwave and Optical Technology Letters*, vol. 56, No. 6, 1471- 1473, June 2014. doi: 10.1002/mop.28363

[8] R. A. dos Santos, I. F. da Costa e A. Cerqueira Júnior; *Novo Modelo de Antena Impressa com Banda Ultralarga. MOMAG 2014: 16º SBMO - Simpósio Brasileiro de Micro-ondas e Optoeletrônica e 11º CBMag - Congresso Brasileiro de Eletromagnetismo*, Curitiba, 2014.

[9] O. P. Lavor, C. G. de Moura, H.C.C. Fernandes and M. P. Sousa Neto, "Analysis of a UWB Planar Antenna with Split Ring Resonator", *Journal of Communications and Information Systems*, vol. 30, No.1, 30-34, march 2015. doi: 10.14209/jcis.2015.4



**Otávio P. Lavor** received the degree of Technologist in Human Resource Management from the Methodist University of São Paulo in 2010, BA in Physics from the State University of Ceará in 2011, graduated in mathematics from the Federal University of Ceará in 2011, specializes in Mathematics from the Faculty Jacarepaguá Integrated in 2012 and the master in Physics from the Federal University of Ceará in 2013. He is currently assistant professor at the Federal Rural University of the Semi-Arid and is in a PhD Program in Electrical and Computer Engineering at the Federal University of Rio Grande of Norte, working in telecommunications, mathematics and applied physics.



**Humberto C. C. Fernandes** was born in Martins-RN, Brazil. Professor. He received laude with the BS in Electrical Engineering from the Federal University of Rio Grande do Norte-UFRN, Brazil in 1977, the MS (1980), PhD (1984) degrees and Postdoctoral program (1986) from the State University of Campinas-UNICAMP, São Paulo, Brazil. His current research interests are microwave, millimeter waves, smart antennas array, superconductivity, semiconductor, neural networks, electromagnetics, photonics, metamaterial, dynamic methods and applications. Since 1978 he is at the Electrical Engineering Department from the UFRN, where he is a Senior Researcher and Professor. Member of the SBrT (Brazilian Telecommunications Society), IEEE ConSOC (USA), SBMO (Brazilian Microwave and Optoelectronics Society), SBPMat (Brazilian Materials Research Society) and Fellow of the Electromagnetics Academy (USA). He has formed more than 40 master students and 9 PhD students.